

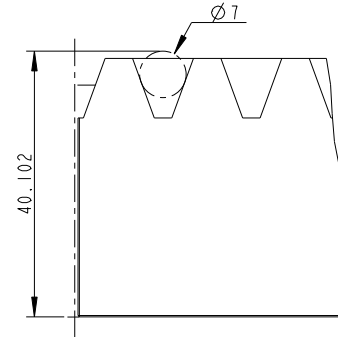

APEX DYNAMICS, INC.

Ordering code	0408R050C10
Module	4
Number of Teeth	38
Pressure angle	20°
Helix angle	19°31'42"RH
Quality	Q8
Total Pitch Error (um)	GTf 68

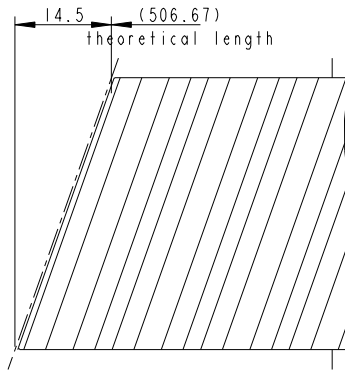

SCALE 4:1

SCALE 4:1

